

Contemporary Slovenian Timber Architecture for Sustainability

Manja Kitek Kuzman, Andreja Kutnar



Contemporary Slovenian Timber Architecture for Sustainability



Contemporary Slovenian Timber Architecture for Sustainability

Series: » Green Energy and Technology

Kitek Kuzman, Manja, Kutnar, Andreja

2014, XIX, 163 p. 218 illus.

Available Formats:

⇅ eBook ⓘ

⇅ Hardcover ⓘ

(gross) price for Austria

⌘ ISBN 978-3-319-03634-2

⌘ free shipping for individuals worldwide

⌘ usually dispatched within 3 to 5 business days November 14, 2014

» auf die Merkliste

Authors, an **architect** and a **wood scientist**, we feel strongly that developments in wood products and timber construction will **shape the future** of sustainable development!

The topics presented in this text range from **green building developments** to national and international legal frameworks that impact **sustainable development and wood use**, from Slovenian forests to developing **architectural design paradigms**.

Why this book?

Authors, Manja Kitek Kuzman, Andreja Kutnar,
about **Contemporary Slovenian Timber
Architecture for Sustainability**



Wood is an abundantly available renewable resource, in Slovenia and many areas of the world. In order to use this resource more effectively we have prepared **this book to help promote interest and collaboration between other architects and scientists who seek to work in sustainable development.**

Topic of global importance

Slovenia – best practice

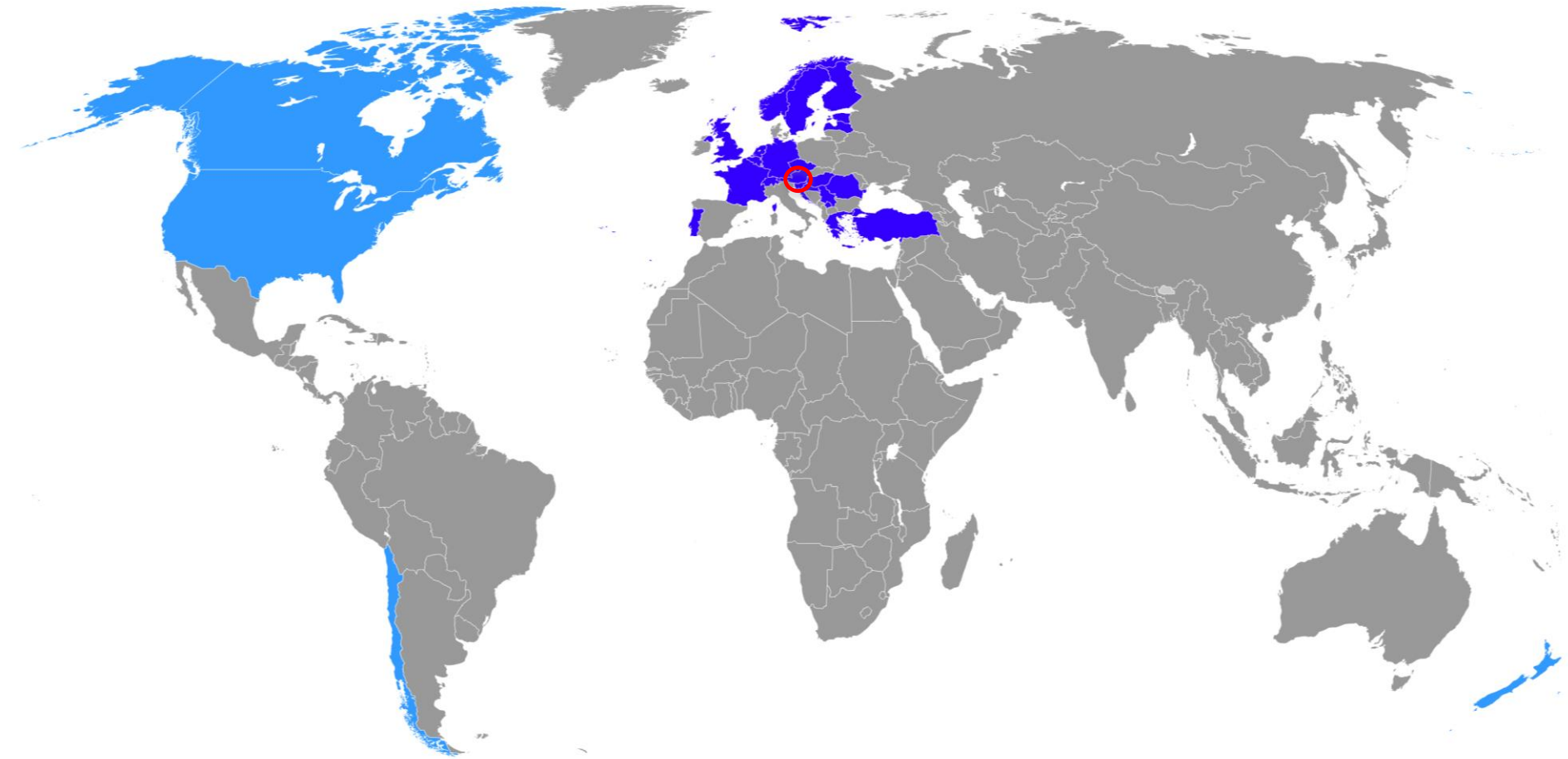

Foreword – worldwide established persons

- **Prof. Dr. Peter Gabrijelčič**, Slovenia
- **Dr. Franz Dolezal**, Austria
- **Prof. Dr. Alfred Teischinger**, Austria
- **Prof. Dr. Parviz Navi**, Switzerland
- **Dr. Andreas Kleinschmit von Lengefeld**, France
- **Prof. Dr. Mark Hughes**, Finland
- **Dr. Lone Ross Gobakken**, Norway
- **Dr. Dennis Jones**, Sweden
- **Prof. Dr. Dick Sandberg**, Sweden
- **Peter Wilson**, United Kingdom
- **Prof. Dr. Callum Hill**, United Kingdom
- **Prof. Dr. Frederick A. Kamke**, USA
- **Dr. Guillermo Martínez Pastur**, Argentina
- **Prof. hon. Julius Natterer**, Switzerland
- **Prof. hon. Roland Schweitzer**, France
- **Robert Widmann**, Switzerland
- **Prof. Dr. Olga Popovic Larsen**, Denmark
- **Prof. Ljubomir Miščević**, Croatia
- **Univ.-Prof. DI Dr.techn. Gerhard Schickhofer**, Austria
- **Alberto Cayuela, P.Eng., PMP, LEED AP**, Canada
- **Prof. Dr. Klaus Richter**, Germany

21 experts, 15 countries



Table of Contents

1 Introduction

- 1.1 Prologue
- 1.2 Sustainable Development and Buildings
- 1.3 Slovenian Forests
- 1.4 Legislations Supporting Timber Constructions

2 Sustainability with Respect to Building Materials

- 2.1 Wood Based Building Materials
- 2.2 Wood Products in Slovenian Timber Architecture
- 2.3 Environmental Impacts of Primary Wood Products

3 Sustainable Buildings

- 3.1 Buildings in Sustainable Development
- 3.2 Timber Construction Systems Found in Slovenia
- 3.3 Building Rating Systems
- 3.4 Environmental Impacts of Buildings

4 Timber Architecture – Case Studies

- 4.1 Individual and Residential Areas
- 4.2 Public Objects



1 Introduction

1.1 Prologue

1.2 Sustainable Development and Buildings

1.3 Slovenian Forests

1.4 Legislations Supporting Timber Constructions

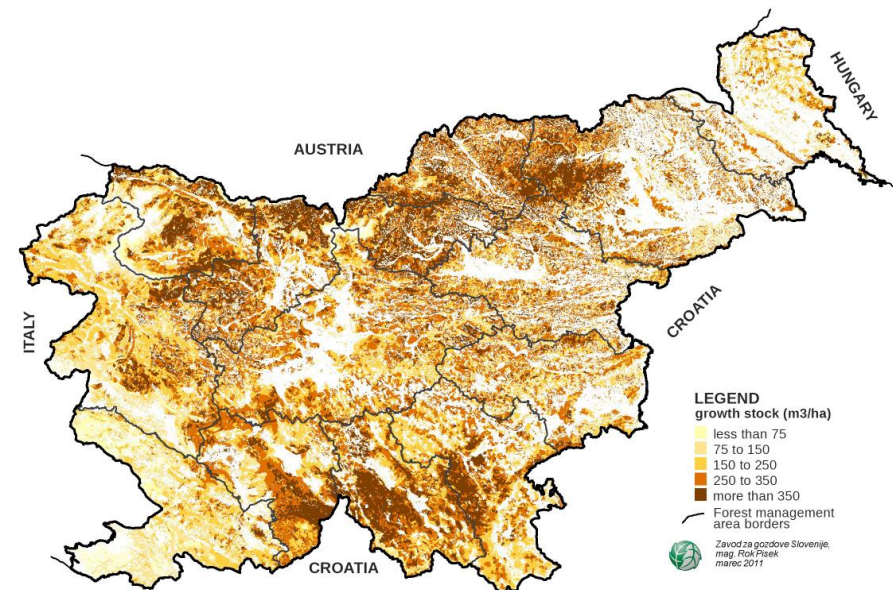
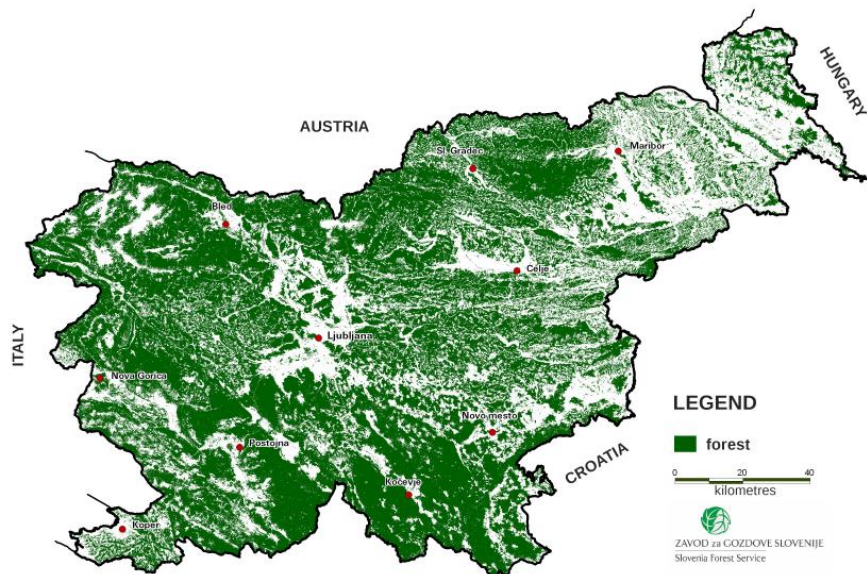

Forest coverage in Slovenia and Slovenian growing stock in m³/ha in 2011 (Slovenia Forest Service, 2014)



2 Sustainability with Respect to Building Materials

2.1 Wood Based Building Materials

2.1.1 Slovenian Primary Wood Products

2.2 Wood Products in Slovenian Timber Architecture

2.3 Environmental Impacts of Primary Wood Products

2.3.1 Carbon Storage in Wood and Wood Products

2.3.2 Environmental Product Declaration, EPD

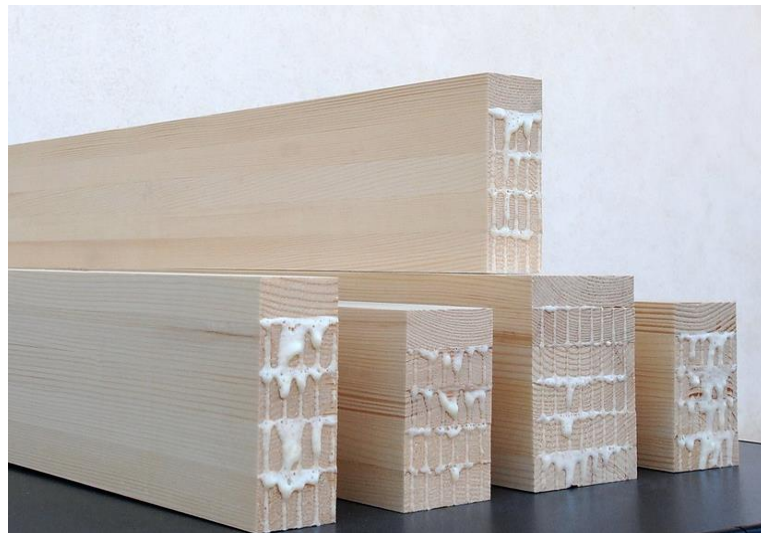

3 Sustainable Buildings

- 3.1 Buildings in Sustainable Development
- 3.2 Timber Construction Systems Found in Slovenia
 - 3.2.1 Panel Construction
 - 3.2.2 Timber Frame Construction
 - 3.2.3 Solid Timber Construction
- 3.3 Building Rating Systems
 - 3.3.1 Certified Buildings in Slovenia
- 3.4 Environmental Impacts of Buildings
 - 3.4.1 Durability of Timber Constructions
 - 3.4.2 Indoor Air Quality

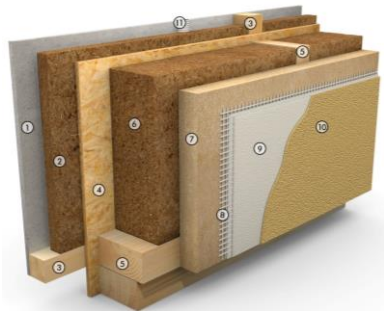

4 Timber Architecture – Case Studies

4.1 Individual and Residential Areas

4.2 Public Objects



RESIDENTIAL BUILDINGS

Lokacija | [Location](#) | Vrhnika

Leta | [Year](#) | 2011

Arhitektura | [Architect](#) | Edvard Blažko, Marko Volk

Projektivno podjetje | [Arhitekturni studio](#) | SoNo arhitekti

Statika | [Structural engineer](#) | Mejra Ogris, Projektivni biro Mejra Ogris s.p.

Energetska učinkovitost | [Energy efficiency](#) | low-energy 50kW /m²a

Površina | [Surface](#) | 307,9 m²

Parcela | [Site area](#) | 850 m²

U-vrednost | [U-value \(W/m²K\)](#) | wall 0,15, roof 0,13, glass 0,70, frame 1,20

Sistem gradnje | [Construction system](#) | timber frame

Izvajalec | [Construction company](#) | Lumar IG d.o.o.

Čas gradnje | [Construction time](#) | 6 mesecev | months

Hišna tehnika | [House technique](#) | air to water heat pump

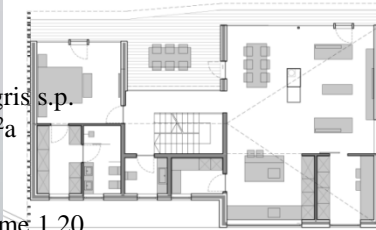
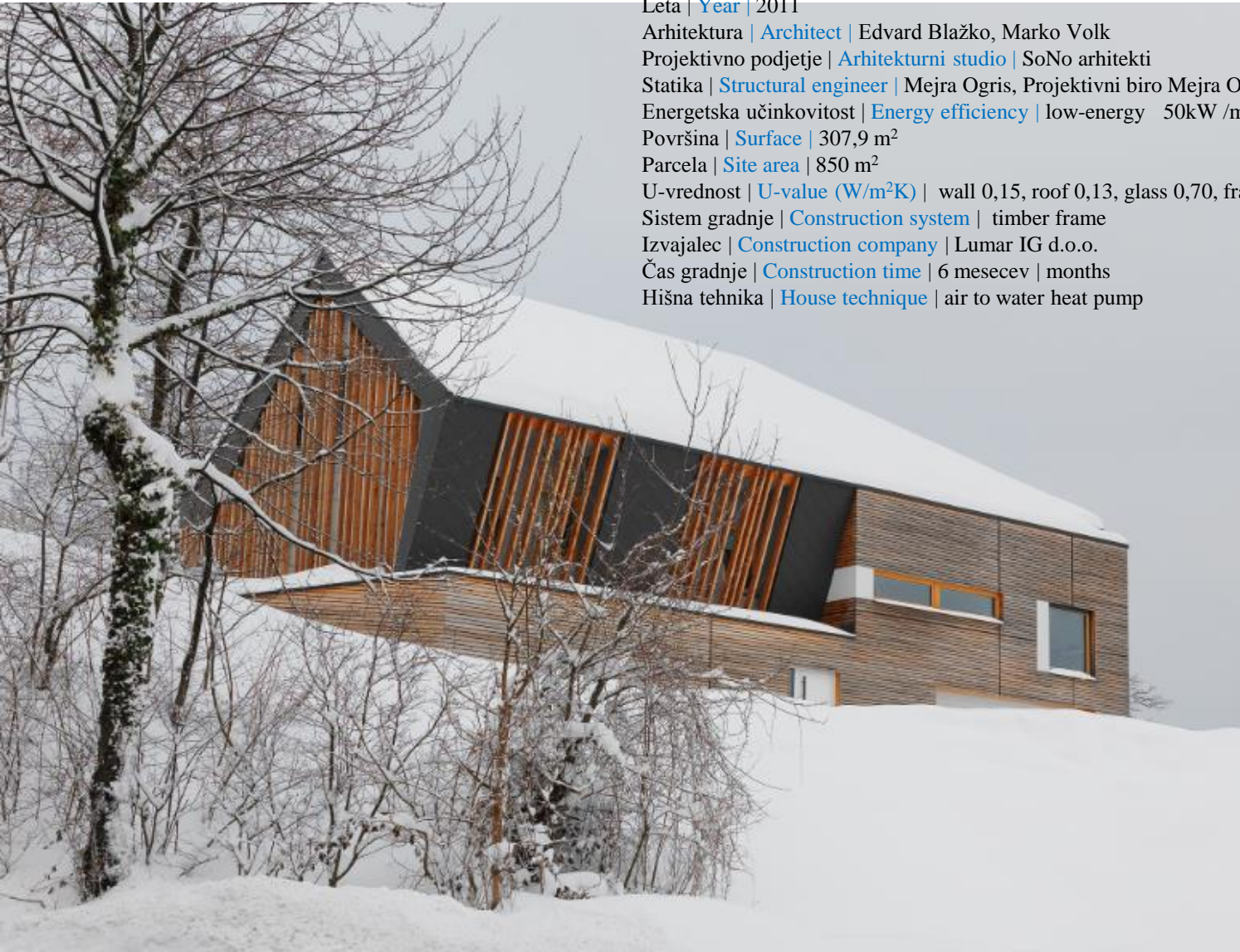

ground floor

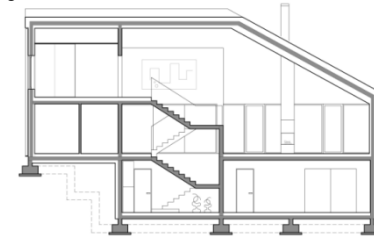

section





New directions- timber healthy material for schools

- 1 ... mavčno vlaknena plošča
Inštalacijska ravnina 40mm
OSB plošča, d=15mm
lesena okvirna konstrukcija, d=160,200,240mm
toplotna izolacija med konstrukcijo
toplotna izolacija na konstrukciji
fasada
- 2 ... vodoodporna izolacija
- 3 ... bitumenska folija - Elotene 1000
- 4 ... hidroizolacija temeljne plošče
- 5 ... izolacija temeljne plošče

Year | 2011
Location | Slovenia
Constructor | Riko hiše d.o.o.
Construction System | Panel construction

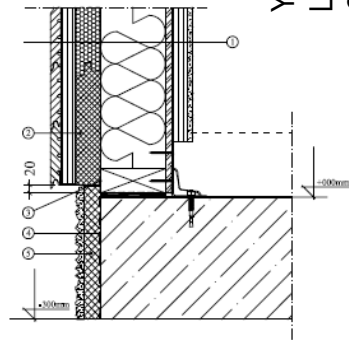

1st price

The 1st National award for the best wood construction 2013

Youth Hostel

Year | 2012

Location | Slovenj Gradec

Massive cross-laminated timber construction



A. Kutnar; Brussels, September 24nd 2014

Contemporary Slovenian Timber Architecture for Sustainability

Manja Kitek Kuzman, Andreja Kutnar

